

INSTRUCTIONS FOR THE 1600 SERIES MICROPROCESSOR BASED TEMPERATURE / PROCESS CONTROL

INCLUDES FUZZY LOGIC OPTION



LOVE CONTROLS DIVISION



Dwyer Instruments, Incorporated

PO Box 338 ○ Michigan City, IN 46361-0338

(800) 828-4588 ○ (219) 879-8000 ○ FAX (219) 872-9057

www.love-controls.com

TABLE OF CONTENTS

GETTING STARTED	2
INSTALLATION	4
DIMENSIONS	5
INPUT SELECTION	5
LOGIC JUMPER SELECTION	6
WIRING	7
FRONT PANEL KEY FUNCTIONS	8
NOTATION CONVENTIONS FOR THE MENUS	10
THE HOME DISPLAY	10
OPERATION OF SELF TUNE® FUNCTION	11
Theory of Operation	11
Program Setup and Operation	12
METHOD FOR SET UP OF A HEAT / COOL CONTROL WITH SELF TUNE	12
PROGRAMMING AND OPERATION FOR RAMP / SOAK FEATURE 13	13
Theory of Operation	13
Program Setup	13
Ramp / Soak Operation	14
MENU SELECTIONS	15
PRIMARY MENU	15
SECONDARY MENU	15
SECURE MENU	21
DIAGNOSTIC ERROR MESSAGES	28
CONFIGURATION MENU	30
SPECIFICATIONS	35

GETTING STARTED

1. Install the control as described on page 4.
2. Make sure that the Input DIP switch is set correctly for the input you wish to use. Instructions on page 5.
3. If you wish to use the Logic (5 VDC) output, make sure that the Logic jumper is in the correct position. See page 6 for details.
4. Wire your control following the drawing on page 7.
5. Make any programming changes necessary first in the Secure Menu (page 21), next in the Secondary Menu (page 15), and finally in the Primary Menu (page 15). DO NOT make changes to the Configuration Menu unless specifically instructed. If you need to back up in a menu, press the INDEX and DOWN ARROW keys together.

6. To quickly return to the HOME position, press the UP ARROW and ENTER keys together, and then the INDEX and DOWN ARROW keys.

Take the example of a Model 16010 that comes from the factory programmed for type J thermocouples. Suppose for this example you wish to change the input to 100 ohm Platinum DIN RTD and limit the set point range between 0° and 500° C.

First, change the input DIP switch as shown on page 5. For RTD inputs switches 1, 3, and 4 are off, switch 2 is on.

Next, enter the Secure menu as instructed on page 8. Press the INDEX key until the display shows **Inp** and press the DOWN ARROW until the display shows **P385**. Don't forget to press the ENTER key to retain your setting.

Next, press the INDEX key to display **Unit**. Press the DOWN ARROW until the display shows **C**. Press ENTER.

Next, press the INDEX key until **SPL** is displayed (pass the **dPt** and **InPt** selections). Press the UP ARROW until the display shows **0**. Press ENTER.

Finally, press INDEX key to display **SPH**. Press the DOWN ARROW until the display shows **500**. Press ENTER.

The necessary program changes are now complete. After 60 seconds the display will switch back to the temperature reading. If you want to return faster, press the UP ARROW and ENTER keys (at the same time) and then press the DOWN ARROW and INDEX keys (again at the same time). This will 'back out' of the menu and immediately display the temperature reading.

If you want to use Self Tune®, Auto/Manual, or the Ramp/Soak Programmer features, see the special sections on these items. Page numbers for these are in the Contents section on the previous page.

INSTALLATION

Mount the instrument in a location that will not be subject to excessive temperature, shock, or vibration. All models are designed for mounting in an enclosed panel.

Select the position desired for the instrument on the panel. If more than one instrument is required, maintain the minimum of spacing requirements as shown on the drawing opposite. Closer spacing will structurally weaken the panel, and invalidate the IP66, UL type 4 rating of the panel.

Prepare the panel by cutting and deburring the required opening.

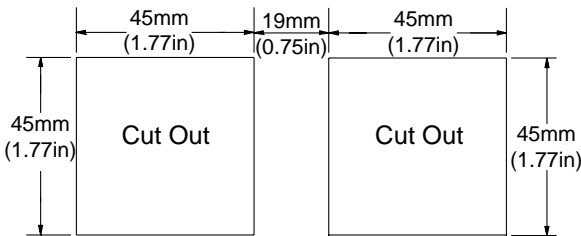

All Tolerances are $-0.00 +0.60\text{mm}$ ($-0.000 +0.020$)

From the front of the panel, slide the housing through the cut out. The housing gasket should be against the housing flange before installing.

From the rear of the panel slide the mounting collar over the housing. Hold the housing with one hand and using the other hand, push the collar evenly against the panel until the spring loops are slightly compressed. The ratchets will hold the mounting collar and housing in place.

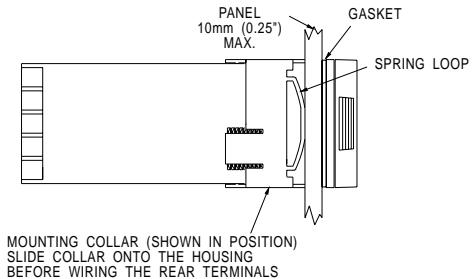

It is not necessary to remove the control chassis from the housing for installation. If the control chassis is removed from the housing, you must follow industry standard practice for control and protection against Electro-Static Discharge (ESD). Failure to exercise good ESD practices may cause damage to the control.

DIMENSIONS

(All dimensions in millimeters with inches in parenthesis.)

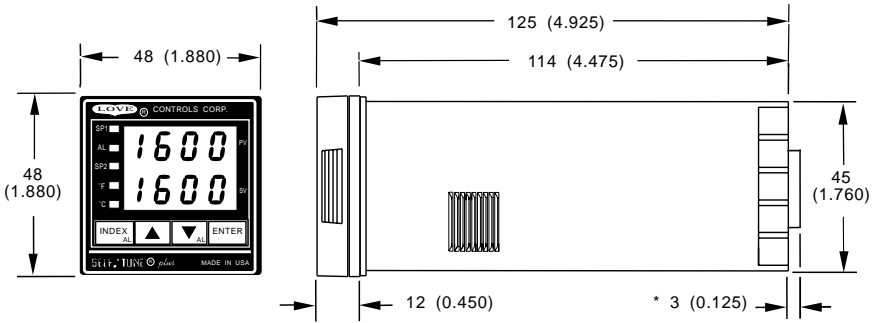

Panel cutout for all models is 45mm x 45mm (1.775 in x 1.775 in).
 Allow for 13 mm (0.5 in) clearance at the rear of the instrument.

* Present for SSR outputs.

INPUT SELECTION

Before removing the instrument from its housing, make sure you take appropriate precautions to avoid electro-static discharge (ESD). See caution on opposite page. To change the input type, remove the instrument from its housing by grasping the front bezel sides and pulling forward to release it from the housing lock.

Locate the dip switch on the right pcb. Determine the input type desired and change the dip switch setting as shown at the right.

Reinstall the instrument into the housing.

After changing input selection with the DIP switches, be sure to change the InP menu item (page 11) in the Secure Menu.

DIP SWITCH LOCATION

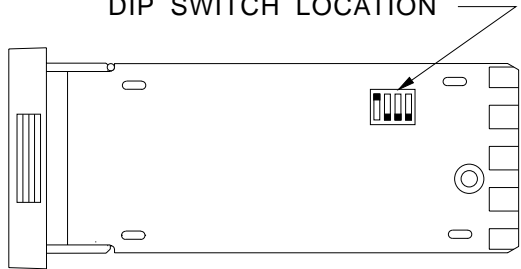

THERMOCOUPLE INPUTS



RTD INPUTS



CURRENT INPUT



VOLTAGE INPUT



LOGIC JUMPER SELECTION

Instruments with **SSR** or **RELAY** type outputs can be changed to and from a **LOGIC** output in the field.



CAUTION: Damage to the instrument may result from an incorrectly installed jumper strip. Follow the instructions carefully. Damage to the instrument may also result from improper handling. Use appropriate precautions to avoid Electro-Static Discharge (ESD).

1. Remove the instrument from its housing. Grasp the front bezel sides and pull forward to release it from the housing lock.

2. Locate the desired logic jumper strip on the left printed circuit board. The **OUTPUT A** jumper strip is always located near the top edge

3. To remove the logic jumper strip, carefully insert a small flat blade screwdriver between the retaining clip and the jumper at one end of the jumper strip. Apply slight pressure to move the clip away from the jumper end until it is released, then lift it up and out of the clip.

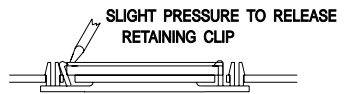
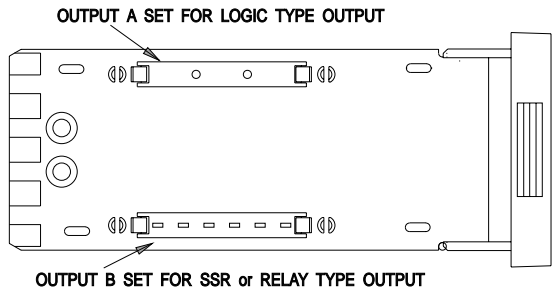

4. To re-install the jumper strip, hold it with the spring contacts in the desired position. Face springs **up** for **SSR** or **RELAY** outputs, or face springs **down** for **LOGIC** outputs. Insert one end of the jumper strip under the retaining clip and press the other end down until the remaining clip engages the jumper.

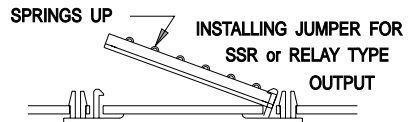
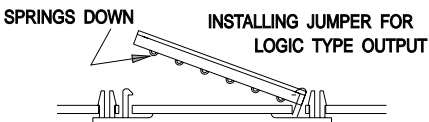

5. To avoid any damage, recheck the jumper installation and the housing rear terminal panel output wiring.

6. Replace the instrument into its housing.

WIRING

INPUTS

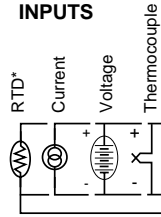

ALARM OUTPUT

Terminals 4 & 5 are Normally Open. See Rating Label.

F1
3/8 A @250 VAC
Medium Lag

* For 2-wire 1000 Ω RTD use terminals 1 & 3.
For 2-wire 100 Ω RTD use terminals 1 & 3, and place a jumper wire between terminals 3 & 4.

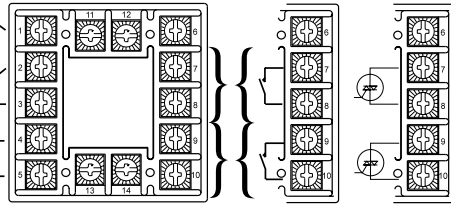

F1
Line Input See Rating Label for details

Relay**
N.O.

Solid State Relay
N.O.

5VDC Output
5V = On, 0V = Off

Current or Voltage

SSR Derating Chart

°C	°F	CURRENT
25	77	3.50
35	95	2.75
45	113	2.00
55	131	1.25

For Relay or SSR outputs use type MDA or 3AB 3.5A medium lag fuse.

** R/C snubber is recommended for driving solenoid or contactor loads.

OPTIONS

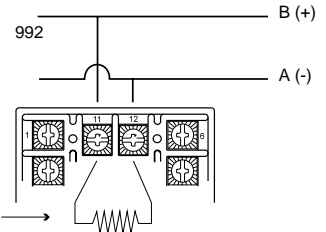
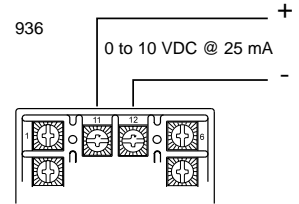
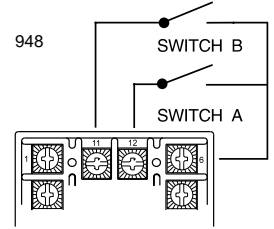

FRONT PANEL KEY FUNCTIONS

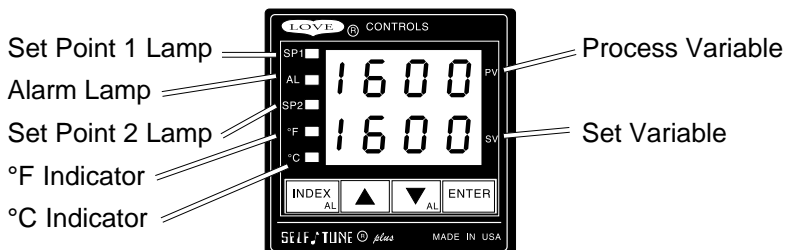

INDEX: Pressing the INDEX key advances the display to the next menu item. May also be used in conjunction with other keys as noted below.



UP ARROW: Increments a value, changes a menu item, or selects the item to ON in the upper display.

DOWN ARROW: Decrements a value, changes a menu item, or selects the item to OFF in the upper display.

ENTER: Pressing ENTER stores the value or the item changed. If not pressed, the previously stored value or item will be retained.

UP ARROW & ENTER: Pressing these keys simultaneously brings up the **secondary menu** starting at the auto/manual selection. Pressing these keys for 5 seconds will bring up the **secure menu**.

INDEX & DOWN ARROW: Pressing these keys simultaneously will allow backing up one menu item, or if at the first menu item they will cause the display to return to the **primary menu**. If an alarm condition has occurred, these keys may be used to reset the alarm.

INDEX & ENTER: Pressing these keys simultaneously and holding them for 5 seconds allows recovery from the various error messages. The following menu items will be reset:

LPbr: Loop break

SEnC: Sensor rate of change

ALiH: Alarm inhibit

OPEn InP: Open input error message

ArEA: Area error message

bAd InP: Bad input error message

CHEC CAL: Check calibration error message

Correct the problems associated with the above conditions first before using these reset keys. More than one error could be present. Caution is advised since several items are reset at one time.

While in the **Primary or Secondary menu**, if no key is pressed for a period of 30 seconds, the display will return to the HOME position displaying the PV and SV values. The time is increased to 1 minute when in the **Secure menu**.

NOTE: To move to the **primary menu** quickly from any other menu, press the **UP ARROW & ENTER** keys followed by pressing the **INDEX & DOWN ARROW** keys.

NOTE: Program the **Secure Menu first**, the **Secondary Menu second**, and the **Primary Menu last**.

SECURITY LEVEL SELECTION

Four levels of security are provided. The display shows the current security level. To change security levels change the password value using the **UP & DOWN ARROW** keys and pressing the **ENTER** key. Refer to the password table below for the correct value to enter for the security level desired. The **SECr** menu item security level may be viewed or changed at any time regardless of the present security level. The password values shown in the table cannot be altered, so retain a copy of this page for future reference. This will be the only reference made to password values in this instruction book.

PASSWORD TABLE

MENU	SECURITY LEVEL SECURITY	DISPLAYED VALUE WHEN VIEWED	PASSWORD VALUE TO ENTER
Primary Secondary Secure	Locked Locked Locked	1	1110
Primary Secondary Secure	Unlocked Locked Locked	2	1101
Primary Secondary Secure	Unlocked Unlocked Locked	3	1011
Primary Secondary Secure	Unlocked Unlocked Unlocked	4	111

NOTATION CONVENTIONS FOR THE MENU

Because of the number of features available in this control, information is included that may not apply to your specific control. All usable features are included in this book, but may not be used in your process. To increase clarity the following conventions are used:

1. Certain features, Menu Items, and functions shown in this book may or may not appear on your control, depending on other Menu Item selections. At various places in the Menus there are notes identifying Menu Items that "control" or "direct" other menu items. If you are looking for a particular menu item and can't find it, check the menu item that is its "control" for proper setting.
2. The "#" symbol is used in two ways. It is used inside a group of characters to indicate which set point function (SP1 or SP2) is being affected. It is also used before a group of characters of a menu item to indicate that there may be more than one selection or value for that menu item.
3. *Features that apply only to Options will be printed in Italics.*

THE HOME DISPLAY

The home display is the normal display while the control is operating. If no errors or functions are active, the HOME display will indicate the Process Variable (the temperature, pressure, flow, RH, etc., that is being measured) on the top display and the Set Variable (Set Point 1) on the bottom.

Items that can change the HOME display are the Auto/Manual function, the Prog function, the **PctO** function, and any error message. Description of these special displays follow.

If Auto/Manual Menu Item is On, the home display is changed. The upper display continues to show the Process Variable (PV), but the lower display changes to show the percentage of output in tenths of a percent to 99.9% (0.0 to 99.9), or 100 if 100%. The display digit to the right of the number shows a flashing letter **o** to indicate that the value displayed is no longer the SV, but percent output. The SP2 output is indicated by the use of an overline on the letter **o**. Access to the SP2 value is done by the INDEX key. See Auto/Manual Operation on Page 13 for further information.

If **Prog** is turned **On**, the HOME display changes the SV display from SP1 to the Present Set Variable as calculated by the Ramp/Soak Programmer function. When Prog is On the StAt Menu Item changes the hHOME display further. When StAt is selected OFF, the HOME display alternately indicates the normal HOME pct and the Ramp/Soak partial status in the Lower Display.

The partial status display sequences with the set value showing the ramp (S1rA) or soak (S1So) segment being processed at that moment. It will also show the Program output status if at Hold or OoFF.

When StAt is selected On, the HOME Display alternately indicates the normal HOME and the Ramp/Soak full status in both the upper and lower displays. The full status display sequences with the set value; Program run, Hold, or OoFF; and with the time remaining for the ramp S1rA or the soak S1So segments. See Programming and Operation for Ramp/Soak Feature below for more information.

If **PctO** (Secondary Menu) is turned **On**, the lower display changes to show the active percentage of output as required to maintain SP1. The display is similar to the Auto/Manual display above, except that the letter indicators do not flash, and the output is displayed in whole percentages of output, not in tenths of a percent. If the control has both SP1 and SP2, the lower display will alternate between the SP1 percent output and the SP2 percent output.

OPERATION OF SELF TUNE® FUNCTION

Self Tune® allows automatic selection of the necessary parameters to achieve best control operation from your 1600 Series control. If you are using the control output as a simple on-off function (**S#Ot** set for **OnOF**), none of the following will apply.

Theory of Operation

The Self Tune function calculates the **Pb1**, **rES**, and **rtE** parameters under the **PID tunE** selection as shown in the Secondary Menu. These values are determined by measuring the response of the process connected to the control. When Self Tune is started, the control temporarily acts as an on-off control. While in this mode the control measures the overshoot and undershoot of the process, and the period of the process (the time from peak value to the next peak value). These measurements are collected over a period that lasts three periods of overshoot and undershoot. The data collected over this time is then compared and calculated into final PID values. The calculations for the PID values are the same as used in the standard Ziegler - Nichols equations that have been recognized as standard for decades.

The only modification to the application of the Ziegler - Nichols equations is controlled by the **dFAC** menu item. This menu item controls the amount of rate (derivative) that is applied. A **dFAC** setting of **3** (factory default) or less allows for less damping. A **dFAC** setting of **4** allows for critical damping as

set forth in Ziegler - Nichols. A **dfAC** setting of **5** or more allows over damping of the process.

Program Setup and Operation

In the secondary menu set **tunE** to **SELF**. Skip **LErn** and check to make sure that **dfAC** is set to the desired value. Back up to **LErn** and set to **YES**. The control will begin the Self Tune function. While the Self Tune function is active, the right hand decimal point on the lower display will blink. When Self Tune is complete, the blinking will stop.

After the initial Self Tune is complete, the instrument will look at the **LErn** menu item to determine if you wish to have the process continually tuned. Setting **LErn** to **Cont** will allow the control to periodically check the tuning parameters. If you wish to have the tuning values locked in, set **LErn** to **End**.

If you wish at any time to view the PID values, change the **tunE** setting to **PID**. This allows examination and / or modification of the values calculated. We recommend that you do not change the calculated values unless you have a firm understanding of the parameters involved and their function. For more information on PID tuning, please contact your supplier.

METHOD FOR SET UP OF A HEAT / COOL CONTROL WITH SELF TUNE

Determine if the process is predominantly heating or cooling. An extruder, for example, is predominantly cooling when running product. An environmental chamber can be either heating or cooling.

If the process is predominantly cooling, set **S1St** to **dir** and **S2St** to **rE**. If the process is predominantly heating, set **S1St** to **rE** and **S2St** to **dir**. Redirect **SP1** to output A or B as required by the hardware (see **SP1o**). Set **S2t** to **dE**. Set **SP2** for zero (no overlap of bands, no deadband). Set **Pb2** to a desired value (default is 12° F). Set **tunE** to **SELF**, **Strt** to **YES**, and **LErn** to **End**.

Start the process and wait for it to come to stability. Occasionally check that the Self Tune has completed the learning process by **INDEXing** to **Strt** in the secondary menu. If the **YES** value has changed to no, then the process has been learned. Once learning is complete, you may adjust **SP2** to either overlap the **SP1** band (**SP2** value less than zero), or add some separation (or dead band) between them (**SP2** greater than zero). Adjust **SP2** as required to optimize control.

PROGRAMMING AND OPERATION FOR RAMP / SOAK FEATURE

The ramp / soak feature offers a great deal of flexibility by allowing changes in the set point to be made over a predetermined period of time.

Theory of Operation

The 1600 Series controls offer a very simple approach to programming a ramp. Rather than requiring the operator to calculate an approach rate (usually in degrees per minute), the 1600 does the calculation internally. Thus, the operator only needs to program the target set point, the time desired to reach that point, and the time desired to hold at that point. When the ramp segment is executed by the control, it calculates the ramp required to move the process from the starting value (current PV) to the desired value (programmed SP) in the time allowed.

Care must be taken, however, that the process does actually reach the soak value before the soak time starts. Make sure to test any program for desired results before running production material.

Do not operate Self Tune while a ramp function is operating. The ramp function will prevent the Self Tune from operating properly. Make sure that all tuning is set up before operating Ramp / Soak.

Program Setup

The programming for the Ramp / Soak function is done in the Secondary Menu.

In the Secondary Menu INDEX to **Prog** and make sure that **Prog** is set to **OFF**.

Skip the **StAt** setting (this is discussed later) and press INDEX to **1rt**.

Set **1rt** to the amount of time you want for the ramp. This value is in time units from **00.01** to **99.59 (hh,mm)**. Press INDEX.

Set **1St** to the amount of time you want for the soak. This value is in time units from **00.01** to **99.59 (hh,mm)**. Press INDEX.

The last menu item for the ramp / soak function is **PEnd**. **PEnd** determines what the control does when the program has ended. You may choose to **Hold** the set point (**SP1**), or turn the outputs off (**OffF**).

Ramp / Soak Operation

When you wish to start the program, enter the Secondary Menu and set the **Prog** menu item to **On**. Return to the HOME position by waiting for the display to time out or by pressing the UP ARROW / ENTER keys and then the DOWN ARROW / INDEX keys.

Changing the AUTO / MANUAL menu item to **Auto OFF** will also suspend the program operation. This also puts the control into manual mode.

Auto / Manual Control

Manual Control is enabled through the Secondary Menu. When Auto is turned On, the lower display in the HOME position will display the output in percent for SP1 or SP2, and is adjustable for each from 0.0 to 100 percent.

SP1 appears first with a flashing "0" on the right hand corner of the lower display to represent percent. Press INDEX to display SP2 output. A flashing "0" will appear on the right hand corner of the lower display to represent percent.

When Manual is enabled, the present control outputs are held (bumpless transfer) and displayed. The output for SP1 or SP2 can then be manually adjusted while displayed by pressing the UP ARROW or DOWN ARROW key to change the value, and then the ENTER key to activate.

The Upper display will normally indicate the Process Value. Since Manual will override most fault messages the upper display could indicate a fault message. Refer to the Diagnostic Error Message Section for further explanation.

MENU SELECTIONS

PRIMARY MENU

Press **INDEX** to scan the Lower Display. Press **UP ARROW** or **DOWN ARROW** to change the value in the upper display.

In the following the symbol "#" will be used before a letter to indicate the set point value to be viewed and/or modified. (Applies to Option 948 only.)

#SP1 (948) or

SP1 Set Point 1, Main Control Point.

SP2 Set Point 2, if equipped.

SECONDARY MENU

Hold **UP ARROW & ENTER**. Press **INDEX** to scan the Lower Display. Press **UP ARROW** or **DOWN ARROW** to change the value in the upper display.

Auto Auto/Manual Control: Select On or OFF.

On Automatic Control

OFF Manual Control is enabled. The lower display in the HOME position will display the output in percent for SP1 or SP2, and is adjustable for each from 0.0 to 100 percent. SP1 appears first with a flashing "o" on the right hand corner of the lower display to represent percent. Press **INDEX** to display SP2 output. A flashing "õ" will appear on the right hand corner of the lower display to represent percent. When Manual is enabled, the present control outputs are held (bumpless transfer) and displayed. The output for SP1 or SP2 can then be manually adjusted while displayed by pressing the **UP** or **DOWN Arrow** key to change the value, and then the **ENTER** key. The Upper display will normally indicate the Process Value. Since Manual will override most fault messages the upper display could indicate a fault message. Refer to the Diagnostic Error Message Section for further explanation.

ALLo Alarm Low: The Low Alarm point is usually set below the Main Set Pt.

ALHi Alarm High: The High Alarm Point is usually set above the Main Set Pt.

- SP** Active setpoint (948): Select **1SP1**, **2SP1**, **3SP1**, or **4SP1**. Allows setting of the multiple stages of SP1, and SP1 tuning constants.
- #SP1** Set Point Value # (948): Select desired value.
- #tun** (948) or
tunE Tuning Choice: Select **SELF**, **Pid**, **SLO**, **nor**, or **FASt**.
- SELF** The Controller will evaluate the Process and select the PID values to maintain good control. Active for SP1 only.
- Strt** Select **YES** or **no**
- YES** Start Learning the Process. After the process has been learned the menu item will revert to **no**.
- no** Learning will stay in present mode.
- LErn** Select **Cont** or **End**
- Cont** Continuously adjust the PID values to maintain the best control. The Process is being monitored at all times by collecting and analyzing the data to adjust the PID values. (adaptive control).
- End** The Process data is collected once and then the PID values are saved, tuning is stopped.
- dFAC** Damping factor, Select **OFF**, **1** to **7**. Sets the ratio of Rate to Reset for the SELF tunE mode. 7 = most Rate. Factory set to 3. For a fast response process the value should be lowered (less Rate). For a slower process the value should be increased (more Rate).
- Pid** Manually adjust the PID values. PID control consists of three basic parameters, Proportional Band (Gain), Reset Time (Integral), and Rate Time (Derivative).
- #Pb1** (948) or
Pb1 Proportional Band (Bandwidth). Select **6** to **5000** °F, **3** to **2778** °C, or **6** to **9999** counts.
- Pb2** Proportional Band (Bandwidth). Select **6** to **5000** °F, **3** to **2778** °C, or **6** to **9999** counts. (Appears after **#rtE** when Option 948 is selected.)
- #rES** (948) or
rES Automatic Reset Time. Select **OFF**, **0.1** to **99.9** minutes. Select **OFF** to switch to **OFS**.
- #OFS** (948) or

- OFS** Manual Offset Correction Select **OFF**, **0.1** to **99.9%**. Select **OFF** to switch to **rES**.
- #rtE** (948) or
- rtE** Rate Time. Select **OFF**, **0.01** to **99.99** minutes, Derivative.
- SLO** PID values are preset for a slow response process.
- nor** PID values are preset for a normal response process.
- FAST** PID values are preset for a fast response process.
- Pid2** Linkage of PID parameters between SP1 and SP2: Select **On** or **OFF**.
- On** Links SP2 to SP1 or *#SP1* rEs and rtE terms for heat/cool applications.
- OFF** Sp2 functions without rEs and rtE.
- ArUP** Anti-Reset Wind-up Feature: Select **On** or **OFF**.
- On** When ArUP is **On** the accumulated Reset Offset value will be cleared to 0% when the process input is not within the Proportional Band.
- OFF** When ArUP is **OFF**, the accumulated Reset Offset Value is retained in memory when the process input is not within the Proportional Band.
- ArtE** Approach Rate Time: Select **OFF**, **0.01** to **99.99** minutes. The function defines the amount of Rate applied when the input is outside of the Proportional Band. The ArtE time and the rtE time are independent and have no effect on each other. To increase damping effect and reduce overshoot set the approach rate time for a value greater than the natural rise time of the process (natural rise time = process value time to set point).
- Fint** *Fuzzy Logic Intensity(942): Select 0 to 100%. 0% is OFF (disables Fuzzy Logic). The function defines the amount of impact Fuzzy Logic will have on the output.*
- Fbnd** *Fuzzy Logic Error Band(942): Select 0 to 4000 °F, 0 to 2222°C, or 0 to 4000 counts. Sets the bandwidth of the Fuzzy Logic. Set Fbnd equal to PID proportional band (Pb1) for best results.*
- FrtE** *Fuzzy Logic Rate of Change(942): Select 0.00 to 99.99°F/sec., 0.00 to 55.55°C/sec., or 0.00 to 99.99 counts/sec. For best initial setting, find the degree/sec change of process value near set point 1 with output ON 100%. Multiply this value by 3. Set FrtE to this calculated value.*

PEA Peak and Valley feature will remember the Highest (**PEA**) and lowest (**VAL**) Input the Instrument has had since the last reset or Power On. At Power On they are reset to the present input, and **VAL** therefore may have to be manually reset. To manually reset the value, PEA or VAL must be in the lower display and then press the **ENTER** key. This will cause the Item to be reset to the present input value.

In the following the symbol "#" will be used following letters to refer to either a number "1" or number "2". The "1" will relate to SP1 functions, the "2" for SP2. If your control is not equipped with a second set point, no SP2 functions will appear. The appearance of **CY#**, **SP#d**, or **PUL#** is dependent upon the output type selected in the Secure Menu item S#Ot. If time proportioning (cycle time) was selected, then CY# is adjustable. If On - Off was selected, then SP#d is adjustable. If pulsed time proportioning was selected then PUL# is adjustable. If none of the above are selected the menu indexes directly to S#Ot.

CY# Cycle Rate: Select **2** to **80** sec. Time Proportioning Control is adjustable in 2 sec. steps. For best contact life, a time should be selected as long as possible without causing the process to wander.

SP#d Set Point On-Off Differential. Select **1** to **1999** deg. or counts. When adjusting SP#d keep in mind that SPL and SPH have to be considered to avoid a CHEC error message.

PUL# Pulsed Time Proportioning Output: Select **1** to **7**. 1 = Linear and 7 = most non-linear. Changes output linearty for use in cooling applications or for an extremely fast response processes. At the

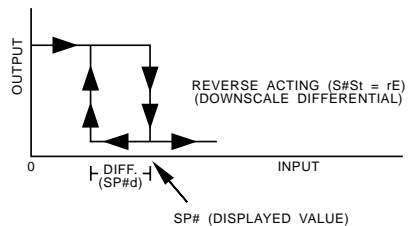
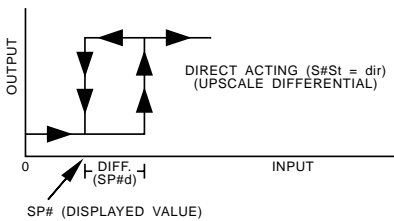

center of the proportional band, a pulse value of 1 provides an output of one second on and one second off (50% output). A pulse value of 2 provides an output of one second on and two seconds off (33% output). Output at center of band equals one second on, $2^{(\text{pulse value}-1)}$ seconds off.

- S#Ot** Set Point Output Type. FT, Curr, or Volt.
Ft refers to Fast Time Proportioning, for Solid State Relay or 5V Logic Outputs. Timing is fixed at 1 sec.
Curr refers to Proportional Current Output of 0 to 20 mA.
Volt refers to Proportional Voltage Output of 0 to 10 V. Both Curr & Volt are selected by the Hardware Configuration Code and cannot be changed.
- PctO** Percent Output Feature: Select **On** or **OFF**.
On When selected **On**, the HOME lower display will indicate the output of the controller in percent. An "o" will appear in the right hand side of the lower display to indicate percent output for SP1. An "ø" will appear on the right hand corner of the lower display to represent percent output for SP2. The display will alternate between these values.
OFF Percent Output display is disabled.
- Prog** Ramp/Soak Feature: Select **On** or **OFF**
- StAt** Status Display in the HOME Position when Prog (above) is On: Select **On** or **OFF**. When selected OFF, the HOME display will alternately indicate the normal HOME and the Ramp/Soak partial status in the Lower Display. The partial status display sequences with the set value showing the ramp (S1rA) or soak (S1So) segment being processed at that moment. It will also show the Program output status if at Hold or OoFF.
When selected On, the HOME Display will alternately indicate the normal HOME and the Ramp/Soak full status in both the upper and lower displays. The full status display sequences with the set value; Program run, Hold, or OoFF; and with the time remaining for the ramp S1rA or the soak S1So segments.
- 1rt** Ramp Time in Hours & Minutes: Select **0.00** to **99.59** (HH.MM).
- 1St** Soak Time in Hours & Minutes: Select **0.00** to **99.59** (HH.MM).
- PEnd** End of Soak action: Select **Hold** or **OoFF**.
Hold Stay at the Present Set Pt.
OoFF Turn Off SP1 and SP2 Outputs at the End of the Soak.
- InPC** Input Correction: Select **±500 °F (±260 °C)** or **±1000** counts. This

is reset to zero when the input type is changed, or when decimal position is changed in T/C or RTD ranges. Changing decimal position in current or voltage ranges will not reset InPC.

FiLt Digital Filter: Select **OFF**, **1** to **99**. In some cases the time constant of the sensor, or noise could cause the display to jump enough to be unreadable. A setting of 2 is usually sufficient to provide enough filtering for most cases, (2 represents approximately a 1 second time constant). When the 0.1 degree resolution is selected this should be increased to 4. If this value is set too high, controllability will suffer.

LPbr Loop Break Protection: Select **OFF**, **1** to **9999** seconds. If, during operation, the output is minimum (0%) or maximum (100%), and the input moves less than 5°F (3°C) or 5 counts over the time set for LPbr, the **LOOP bAd** message will appear. This condition can also be routed to an Alarm Condition if alarms are present and turned On (see ALbr in the secure menu). The loop break error can be reset by pressing the **ENTER** key when at the LPbr menu item. The **INDEX & ENTER** keys may also be used.

POL *Process Output Low (936): Select -450°F, -260°C, or -1999 counts to 50 degrees or counts less than **POH**.*

POH *Process Output High (936): Select from 50 degrees or counts greater than **POL** to +9990°F, +5530°C, or 9990 counts. A voltage output is scalable from 0 to 10 VDC that represents the Process Variable. To properly scale the output, the values for **POL** and **POH** must be calculated. The simplest example is an output of 0 to 10 VDC from 0 to 200°. In this example **POL**=0 and **POH**=200. To Calculate POL and POH for other ranges use the following:*

K = (Highest desired temperature - Lowest desired temperature) / (Maximum desired voltage - Minimum desired voltage)

POH = ((10 - Maximum desired voltage) * K) + Highest desired temperature

POL = ((Minimum desired voltage - 0) * K) - Lowest desired temperature

LOrE *Local / Remote Status (992): Select **LOC** or **rE**.*

LOC *Write commands from the host computer are rejected.*

rE *Write commands from the host computer are accepted. The control will also look to the No Activity Timer (**nAt**) setting to see if regular host computer commands are required. See **nAt** and **CFLt** (Page 27) for additional information.*

CFSP *Communications Fail Set Point (992): Set to desired value.*

Addr *Control Address (992): Set from 1 to FF. This number (hexadecimal, base 16) must match the address number used by the host computer. Viewed only in this menu.*

SECURE MENU

Hold **UP ARROW & ENTER** for 5 Seconds. Press **INDEX** to change the lower display. Press **UP ARROW** or **DOWN ARROW** to change the value in the upper display.

SECr Security Code: See the Security Level Selection and the Password Table in this manual, in order to enter the correct password.

InP Input Type: Select one of the following. The Inputs are based on four different groups; Thermocouples, RTD's, Current, and Voltage. If changing from one of these groups, the DIP switch on the A/D circuit board will have to be changed to match that particular group. Refer to the Input wiring section for the proper switch settings.

- J-IC** Type "J" Thermocouple
- CA** Type "K" Thermocouple
- E-** Type "E" Thermocouple
- t-** Type "T" Thermocouple
- L-** Type "L" Thermocouple
- n-** Type "N" Thermocouple
- r-13** Type "R" Thermocouple
- S-10** Type "S" Thermocouple
- b-** Type "B" Thermocouple
- C-** Type "C" Thermocouple
- P392** 100 ohm Platinum (NIST 0.00392 $\Omega/\Omega/^\circ\text{C}$), Love Cal. 104.
- n120** 120 ohm Nickel, Love Cal. 105.
- P385** 100 ohm Platinum (DIN 0.00385 $\Omega/\Omega/^\circ\text{C}$), Love Cal. 106.
- Curr** DC Current Input 0.0 to 20.0 or 4.0 to 20.0 milliamperes.
- UoLt** DC Voltage Input 0.0 to 5.0 or 1.0 to 5.0 volts.
- Reserved

OSUP Zero Suppression: Select **On** or **OFF**. Only with Current and Voltage input types.

OFF The input range will start at 0 (zero) Input.

On The input range will start at 4.00 mA or 1.00 V.

- Unit** Select **F**, **C**, or **nonE**.
- F** °F descriptor is On and temperature inputs will be displayed in actual degrees Fahrenheit.
 - C** °C descriptor is On and temperature inputs will be displayed in actual degrees Celsius.
 - nonE** °F and °C descriptors will be Off. This is only available with Current and Voltage Inputs.
- dPt** Decimal Point Positioning: Select **0**, **0.0**, **0.00**, or **0.000**. On temperature type inputs this will only effect the Process Value, **SP1**, **SP2**, **ALLo**, **ALHi**, and **InPC**. For Current and Voltage Inputs all Menu Items related to the Input will be affected.
- 0** No decimal Point is selected. This is available for all Input Types.
 - 0.0** One decimal place is available for Type J, K, E, T, L, RTD's, Current and Voltage Inputs.
 - 0.00** Two decimal places is only available for Current and Voltage Inputs.
 - 0.000** Three decimal places is only available for Current and Voltage inputs.
- InPt** Input Fault Timer: Select **OFF**, **0.1** to **540.0** minutes. Whenever an Input is out of range, shorted, or open the timer will start. When the time has elapsed, the controller will revert to a safe condition (Outputs Off, Flashing Displays). If OFF is selected, the Input Fault Timer will not be recognized (time = infinite).
- SEnC** Sensor Rate of Change: Select **OFF**, **1** to **4000** °F, °C, or counts per 1 second period. This value is usually set to be slightly greater than the fastest process response expected during a 1 second period, but measured for at least 2 seconds. If the process is faster than this setting, the SEnC bAd error message will appear. The outputs will then be turned off. This function can be used to detect a runaway condition, or speed up detection of an open thermocouple. Use the **INDEX & ENTER** keys to reset.
- SCAL** Scale Low: Select **100** to **9999** counts below **SCAH**. The total span between **SCAL** and **SCAH** must be within 11998 counts. Maximum setting range is -1999 to +9999 counts. For Current and Voltage inputs, this will set the low range end. Viewable only for Thermocouples and RTD's.
- SCAH** Scale High: Select **100** to **9999** counts above **SCAL**. The total span between **SCAL** and **SCAH** must be within 11998 counts. Maximum setting range is -1999 to +9999 counts. For Current and

Voltage inputs, this will set the high range end. Viewable only for Thermocouples and RTD's.

- SPL** Set Point Low: Select from **SCAL** value to **SPH** value. This will set the minimum SP1, SP2, ALLo, ALHi, SP1d, and SP2d values that can be entered. If any of the values are less than the SPL value, a check message will appear and the value will not be accepted.
- SPH** Set Point High: Select from **SCAH** value to **SPL** value. This will set the maximum SP1, SP2, ALLo, ALHi, SP1d, and SP2d values that can be entered. If any of the values are greater than the SPH value, a check message will appear and the value will not be accepted.
- SP1o** Set Point 1 Output Terminal Assignment: Select **OutA** or **Outb**.
NOTE: Reassigning the output terminals does not change the Hardware type assigned to those terminals. For single set point models, SP1o is locked to OUT A.
- OutA** Set Pt. 1 output will be directed to terminals 7 & 8 and Set Pt. 2 output to terminals 9 & 10.
- Outb** Set Pt. 1 output will be directed to terminals 9 & 10 and Set Pt. 2 output to terminals 7 & 8.
- S#Ot** Set Point Output Type: Select **CY**, **OnOF**, **PUL**, or **Ft**. Fixed for Curr and Volt, the Hardware Configuration has selected this.
- CY** Cycle Rate, Adjustable Time Proportioning.
CY# Cycle Rate Time: Select **2** to **80** sec.
- OnOF** On/Off Output.
SP#d Set Point Differential in 1 degree or count steps from 2 degrees or counts to full scale, but limited by SPL and SPH.
- PUL** Pulse Time Proportioning.
PUL# Pulse Width Value: Select **1** to **7**.
- Ft** Fast Time Proportioning: Fixed at 1 sec. Time Base.
- Volt** Proportional Voltage, 0 to 10 V.
- Curr** Proportional Current, 0 to 20 mA.
- S#St** Set Point State: Select **dir** or **rE**.
- dir** Direct Action. As the input increases the output will increase. Most commonly used in cooling processes.
- rE** Reverse Action. As the input increases the output will decrease. Most commonly used in heating processes.

- S#OL** Set Point Output Low Limit: Select **0** to **90%** but less than **S#OH**. This item limits the lowest output value. This is useful for adding a bias to the process when needed. When a current or voltage output is used, the standard output value is 0 to 20mA or 0 to 10V. If 4 to 20 mA or 2 to 10 V is required, the S#OL value should be set for 20% to raise the lowest output.
- S#OH** Set Point Output High Limit: Select **10** to **102%** but greater than **S#OL**. This item allows setting the maximum output limit. This is useful with processes that are over powered.
- S#LP** Set Point Lamp: Select **O on** or **OoFF**.
O on Lamp ON when Output is ON.
OoFF Lamp OFF when Output is ON.
- S2t** Set Point 2 type: Select **AbS** or **dE**.
AbS Absolute SP2. SP2 is independent of SP1, and may be set anywhere between the limits of SPL and SPH.
dE Deviation SP2. SP2 is set as a deviation from SP1, and allows SP2 to retain its relationship with SP1 when SP1 is changed (tracking SP2).

ALARM TYPE AND ACTION



Caution: In any critical application where failure could cause expensive product loss or endanger personal safety, a redundant limit controller is recommended.

When setting an alarm value for an absolute alarm (ALt = AbS), simply set the value at which the alarm is to occur.

When setting the alarm value for a deviation alarm (ALt = dE), set the difference in value from the Set Value (SV) desired. For example if a low alarm is required to be 5 degrees below the SV, then set ALLo to -5. If a high alarm is required 20 degrees above the SV, then set ALHi to +20. If SP1 is changed, the alarm will continue to hold the same relationship as originally set.

The following diagram shows the action and reset functions for both absolute and deviation alarms.

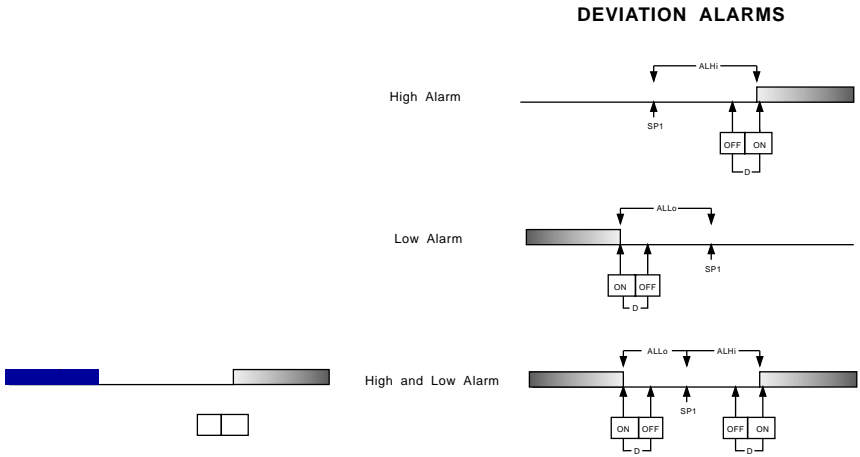

When “Alarm Power Interrupt” ALPi is programmed ON and “Alarm Reset” is programmed for Hold, the alarm will automatically reset upon a power failure and subsequent restoration if no alarm condition is present.

If “Alarm Inhibit” ALiH is selected ON, an alarm condition is suspended upon power up until the process value passes through the alarm set point once. Alarm inhibit can be restored as if a power up took place by pressing together the **INDEX** and **ENTER** keys for 5 seconds.

WARNING: IF INHIBIT IS ON AND A POWER FAILURE OCCURS DURING A HIGH ALARM, RESTORATION OF POWER WILL NOT CAUSE THE ALARM TO OCCUR IF THE PROCESS VALUE DOES NOT FIRST DROP BELOW THE HIGH ALARM SETTING. DO NOT USE THE ALARM INHIBIT FEATURE IF A HAZARD IS CREATED BY THIS ACTION. BE SURE TO TEST ALL COMBINATIONS OF HIGH AND LOW ALARM INHIBIT ACTIONS BEFORE PLACING CONTROL INTO OPERATION.

The following Secure menu items apply only to the alarm.

- AL** Alarms: Select **OFF**, **Lo**, **Hi**, or **HiLo**.
- OFF** Alarms are turned OFF. No Alarm menu items appear in the Secondary and Secure menus.
 - Lo** Low Alarm Only. ALLo appears in the Secondary Menu.
 - Hi** High Alarm Only. ALHi appears in the Secondary Menu.
 - HiLo** High and Low Alarms. Both share the same Alarm Relay output.

ALt Alarm Type: Select **AbS** or **dE**
AbS Absolute Alarm that may be set anywhere within the values of SPL and SPH and is independent of SP1.
dE Deviation Alarm that may be set as an offset from SP1. As SP1 is changed the Alarm Point will track with SP1.

ALrE Alarm Reset: Select **OnOF** or **Hold**.
OnOF Automatic Reset.
Hold Manual Reset. Acknowledge by simultaneously pressing the **INDEX & DOWN ARROW** keys for 5 sec.

ALPi Alarm Power Interrupt: Select **On** or **OFF**.
On Alarm Power Interrupt is ON.
OFF Alarm Power Interrupt is OFF.

ALiH Alarm Inhibit: Select **On** or **OFF**.
On Alarm Inhibit is ON. Alarm action is suspended until the process value first enters a non-alarm condition.
OFF Alarm Inhibit is OFF.

ALSt Alarm Output State: Select **CLOS** or **OPEn**.
CLOS Closes Contacts at Alarm Set Point.
OPEn Opens Contacts at Alarm Set Point.

ALLP Alarm Lamp: Select **O on** or **OoFF**.
O on Alarm Lamp is ON when alarm contact is closed.
OoFF Alarm Lamp is OFF when alarm contact is closed.

ALbr Alarm Loop Break: Select **On** or **OFF**.
On Loop Break Condition will cause an Alarm Condition.
OFF Loop Break will not affect the Alarm Condition.

The following Secure menu items apply only to Options. They may not appear in your control.

SPSA *Set Point Select Action (948): Select **rE** or **Int**.*
rE *Remote (external) selection of active set point value.*
Int *Internal selective of active set point value.*

Addr *Control Address (992): Set from 1 to FF. This number (hexadecimal, base 16) must match the address number used by the host computer.*

- bAUd** *Communications baud rate (992): Select 300, 1200, 2400, 4800, 9600, 19.2, 28.8, or 57.6. This number must match the baud rate used by the host computer. The data format is 8 bits, 1 stop bit, No parity.*
- nAt** *No Activity Timer (992): Select OFF to 99. If a number is set, the control will expect access by the host computer. If no access is detected within that time, the control will indicate an error, **CHEC LorE** and go to the set point indicated by **CFLt**.*
- CFLt** *Communication Fault Mode (992): Select 1 or 2. 1 = On Communication fault use local Set Point. 2 = On Communications fault use **CFSP**.*

DIAGNOSTIC ERROR MESSAGES

DISPLAY	MEANING	SP OUTPUTS	ACTION REQUIRED
UFL or OFL	Underflow or Overflow: Process value has exceeded input range ends.	Set point outputs active Alarm active	Input signals may normally go above or below range ends. If not, check input and correct.
	UFL or OFL will sequence to display one of these messages if the InPt is set for a time value.	Set point outputs inactive Alarm active	To reset use the INDEX & ENTER keys. When InPt (input fault timer) has been set for a time, the outputs will be turned off after the set time. Setting the time to OFF causes the outputs to remain active, however UFL or OFL will still be displayed.
bAd InP	For RTD inputs RTD is open or shorted.		Correct or replace sensor. To reset use the INDEX & ENTER keys.
OPEn InP	For THERMOCOUPLE inputs thermocouple is open.		Correct or replace sensor. To reset use the INDEX & ENTER keys.
LOOP bAd	The sensor may be defective, heater fuse open, heater open, or the final power output device is bad.	Set point outputs inactive. Alarm active.	Correct or replace sensor, or any element in the control loop that may have failed. Correct the problem, and reset the control by pressing the INDEX and ENTER keys, or index to LPbr and press ENTER .
SEnC bAd	Sensor Rate of Change exceeded the programmed limits set for SEnC .	Set point outputs inactive. Alarm Active	Check for the cause of the error. The value setting may be too slow for the process, or the sensor is intermittent. Correct the problem and press INDEX and ENTER to reset.
CHEC CAL	Check calibration appears as an alternating message if the instrument calibration nears tolerance edges.	Set point outputs active Alarm active	Remove the instrument for service and / or recalibration. To reset use the INDEX & ENTER keys.
	Check calibration appears as a flashing message if the instrument calibration exceeds specification.	Set point outputs inactive Alarm active	Remove the instrument for service and / or recalibration. To reset use the INDEX & ENTER keys.

DIAGNOSTIC ERROR MESSAGES

DISPLAY	MEANING	SP OUTPUTS	ACTION REQUIRED
No display lighted	Display is blank. Instrument is not getting power, or the supply voltage is too low.	Set point outputs inactive Alarm inactive	Check that the power supply is on, or that the external fuses are good.
FAIL tEst	Fail test appears upon power up if the internal diagnostics detect a failure. This message may occur during operation if a failure is detected. Displays flash.	Set point outputs inactive Alarm inactive	The display alternate between FAIL tEst and one of the following messages: FACT dFLt : Memory may be corrupted. Press the ENTER key and the DOWN ARROW key to start the factory default procedure (Page 30). Recheck controller programming. rEt FACT : Unrecoverable error, return to factory for service.
CHEC SP1, CHEC SP2, CHEC 1rt, CHEC 1St,	This message will appear upon power up if SP1, SP2, 1rt, or 1St is set outside of the SPL or SPH values.	Set point outputs inactive Alarm active	Correct the SP1, etc. or adjust the SPL or SPH values by programming new values.
CHEC SPL or CHEC SPH	This message appears at power up if SPL or SPH values are programmed outside the input range ends.	Set point outputs inactive Alarm inactive	Correct the SPL or SPH values by programming new values.
CHEC rSpt	This message appears if the analog remote set point signal is out of range.	Set point outputs active Alarm inactive	The control will revert to SP1. Correction of the analog signal allows the control to return to the remote
CHEC LorE	This message appears if the Serial Communications has timed out.	Set point outputs active Alarm inactive	Restore the communications line and switch the LorE to LOC.
ArEA	This message appears if the ambient temperature of the control is near or out of range or RJC sensor is broken.	Set point outputs active Alarms active	Correct the ambient temperature conditions. Ventilate the area of the cabinet or check for clogged filters. If RJC broken, return to factory for service.

CONFIGURATION MENU



DO NOT ENTER THE CONFIGURATION MENU UNLESS YOU HAVE BEEN INSTRUCTED TO BY ANOTHER PART OF THESE INSTRUCTIONS. INCORRECT ENTRY OF DATA IN THE CONFIGURATION MENU MAY PREVENT YOUR CONTROL FROM OPERATING PROPERLY.

The Configuration Menu is used to quickly configure the instrument. The configuration for your particular model is shown on the Model / Serial label located on the top of the instrument housing. A label found inside on the right printed circuit board only shows the hardware configuration and options.

The numbers shown are defined as follows:

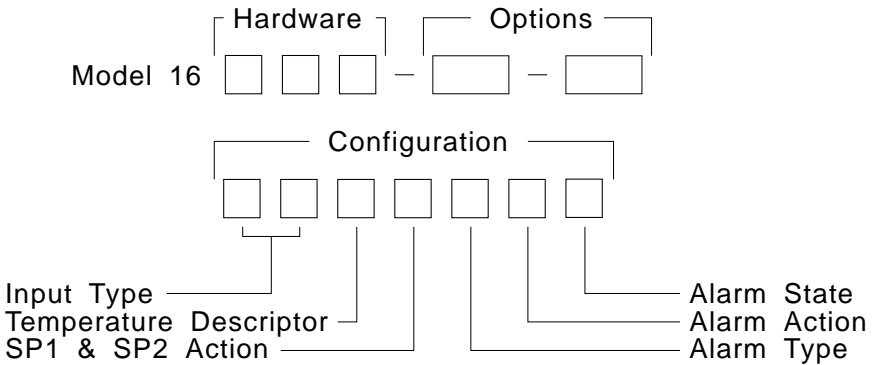

The Hardware configuration code **must not** be changed as it defines the hardware for the specific instrument. All other configuration may be altered if necessary. It is important that the codes be correctly entered in order for the instrument to function properly. If an invalid code number is entered for a particular configuration item, it will not be accepted and the old configuration code will be retained.

If you wish to return the settings to the factory default values, follow step 1 below to enter the configuration menu. Then skip to step 13 and follow the directions there.

To re-configure:

1. At power up, simultaneously press and hold the **INDEX & ENTER** keys while the lamp test or self test is displayed. Hold the keys down until **Hrd1** appears. A dash appears in the upper display.
2. If your control is equipped with the optional alarm, press the UP ARROW until the upper display reads 1, and press ENTER.

3. Press the **INDEX** key to advance to the next menu item, **Hrd2**. Press the UP ARROW until the upper display shows the number code for Output A (Set Point 1). Acceptable values are 1, 2, 3, and 4 (for 5 VDC, mechanical relay, and SSR outputs); 5 (for proportional current output); or 6 (for proportional voltage output). Press ENTER.
3. Press INDEX to **Hrd3**. If your instrument is equipped with an optional second set point (Output B, Set Point 2), press the UP ARROW key to select the desired value. Acceptable values are 0 (no Output B), 1, 2, 3, and 4 (for 5 VDC, mechanical relay, and SSR outputs). Press ENTER.
4. Press INDEX to **OPT1**. If your instrument is equipped with an option, press the UP ARROW or DOWN ARROW as necessary to display the option number. The option number will be flashing. To select the option, press ENTER while the option number is displayed. When selected, the option number will stop flashing. **DO NOT SELECT AN OPTION IF THE INSTRUMENT DOES NOT HAVE THE HARDWARE TO SUPPORT IT. SELECTION OF AN UNSUPPORTED OPTION MAY CAUSE IMPROPER OPERATION OF THE INSTRUMENT.**
6. If you wish to program the menu pre-sets (configuration), press INDEX to **CnF1**. To preset the input type press the UP Arrow or DOWN ARROW for the following selections:

01 - Type J, whole degree	14 - Type S, whole degree
02 - Type J, tenth degree	15 - Type B, whole degree
03 - Type K, whole degree	16 - Type C, whole degree
04 - Type K, tenth degree	17 - DIN RTD, whole degree
05 - Type E, whole degree	18 - DIN RTD, tenth degree
06 - Type E, tenth degree	19 - NIST RTD, whole degree
07 - Type T, whole degree	20 - NIST RTD, tenth degree
08 - Type T, tenth degree	21 - Ni RTD, whole degree
09 - Type L whole degree	22 - NI RTD, tenth degree
10 - Type L, tenth degree	23 - 0 to 20 mA
11 - Type N whole degree	24 - 4 to 20 mA
12 - Type N, tenth degree	25 - 0 to 5 V
13 - Type R, whole degree	26 - 1 to 5 V

Factory default is 01 - Type J, whole degree.
6. Press INDEX to **CnF2**. If CnF1 is equal to 01 through 22, press UP ARROW to select 1 for degrees F or 2 for degrees C. If CnF1 is equal to 23 through 26, press UP ARROW to select 0 for no descriptor, 1 for degrees F, or 2 for degrees C. **Factory default is 1, degrees F.**
7. Press INDEX to **CnF3**. Press UP ARROW to select one of the following: (if **Hrd3** = 0)
 - 0 - SP1 is on Output A and is reverse acting
 - 1 - SP1 is on Output A and is direct acting
 (If **Hrd3** ≠ 0)
 - 2 - SP1 on Output A & reverse acting, and SP2 on Output B & direct acting

- 3 - SP1 on Output B & reverse acting, and SP2 on Output A & direct acting
- 4 - SP1 on Output A & direct acting, and SP2 on Output B & reverse acting
- 5 - SP1 on Output B & direct acting, and SP2 on Output A & reverse acting
- 6 - SP1 on Output A & reverse acting, and SP2 on Output B & reverse acting
- 7 - SP1 on Output B & reverse acting, and SP2 on Output A & reverse acting
- 8 - SP1 on Output A & direct acting, and SP2 on Output B & direct acting
- 9 - SP1 on Output B & direct acting, and SP2 on Output A & direct acting

Factory default for single set point units is 0. Factory default for dual set point units is 2.

If **Hrd1** = 0 you may skip steps 8 - 10. Press INDEX three times to proceed to step 11, **ACPt**.

If **Hrd1** = 1 then continue with step 8.

8. Press INDEX to **CnF4**. Select the desired alarm type from the following list:
 - 0 - No Alarm (This may be selected even if **Hrd1** = 1)
 - 1 - High Alarm, Absolute Setting
 - 2 - High Alarm, Deviation Setting from SP1
 - 3 - Low Alarm, Absolute Setting
 - 4 - Low Alarm, Deviation Setting from SP1
 - 5 - High and Low Alarm, Absolute Settings
 - 6 - High and Low Alarm, Deviation Settings from SP1

Factory default is 0 if **Hrd1** = 0, 1 if **Hrd1** = 1.
9. Press INDEX to **CnF5**. Select the desired alarm action from the following list:
 - 0 - No Alarm
 - 1 - Alarm acts as on/off output
 - 2 - Alarm requires manual reset & has power interrupt feature on
 - 3 - Alarm requires manual reset & has power interrupt feature off
 - 4 - Alarm acts as on/off output & has inhibit feature
 - 5 - Alarm requires manual reset and has inhibit feature

Factory default is 0 if **Hrd1** = 0, 1 if **Hrd1** = 1.
10. Press INDEX to **CnF6**. Select the alarm relay state from the following list:
 - 0 - No Alarm
 - 1 - Alarm relay closes at the alarm point, alarm lamp flashes
 - 2 - Alarm relay opens at the alarm point, alarm lamp flashes
 - 3 - Alarm relay closes at the alarm point, alarm lamp is off
 - 4 - Alarm relay opens at the alarm point, alarm lamp is off

Factory default is 0 if **Hrd1** = 0, 1 if **Hrd1** = 1.
11. Press INDEX to **ACPt**. If you do not want to retain the re-configuration, this is your last chance to return to the old configuration. Press ENTER at **ACPt no** to exit and retain the old configuration. Otherwise, press UP ARROW and ENTER at **ACPt YES** to retain the new configuration.
12. Press INDEX to **id**. This display shows the version code for the software in the instrument. If you believe that the control is not performing

properly, you may wish to make note of this code and reference it when reporting your experiences to us.

13. Press INDEX to FACt dFLt. This function restores the control to original factory settings. It will also remove all of the hardware, option, and software configuration values. After selecting FACt dFLt you will need to restore the hardware and option configuration values to allow the instrument to operate correctly.

To restore factory default values, press and hold the ENTER key. While holding the ENTER key also press the DOWN ARROW key. The display will blink momentarily and the instrument will reboot. The instrument will then display Hrd1. Follow these instructions resuming at step 2.

Note: The Configuration Menu is a "one way" menu. It is not possible to view a previous configuration by entering the configuration menu.

Input Ranges (Field Selectable)

Thermocouple Types

Input Type	Type J or L*	Type K*	Type T*	Type E*
Range 1°F 1°C	-100 to +1600 -73 to +871	-200 to +2500 -129 to +1371	-350 to +750 -212 to +398	-100 to +1800 -73 to +982
Input Type	Type R	Type S	Type B	Type C
Range 1°F 1°C	0 to 3200 -17 to +1760	0 to 3200 -17 to +1760	+75 to 3308 +24 to 1820	0 to 4208 -17 to 2320
Input Type	Type N*	* These Input Types can be set for 0.1° display. If temperature goes above 999.9° or less than -199.9° the display will return to whole degree resolution.		
Range 1°F 1°C	-100 to +2372 -73 to +1300			

RTD Types

Option 965

Input Type	100 Ohm Platinum 0.00385 DIN Curve*	100 Ohm Platinum 0.00392 Nist Curve*	120 Ohm Nickel 0.00628 US Ind. Curve*	1000 Ohm Platinum 0.00385 Nist Curve*
Range 1°F 1°C	-328 to +1607 -200 to +875	-328 to +1607 -200 to +875	-112 to +608 -80 to +320	-328 to +1607 -200 to +875

Process Input Types

The 0 to 20 mAdc, 4 to 20 mAdc, 0 to 10 Vdc, 2 to 10 Vdc, and -10 to +10 mVdc inputs are fully scalable from a minimum of 100 counts span placed anywhere within the within the range of -1999 to +9999. Decimal point position is adjustable from the zero place (9999), tenths (999.9), hundredths (99.99), thousandths (9.999), or ten thousandths (.9999).

SPECIFICATIONS

Selectable Inputs: Thermocouple, RTD, current or voltage.

Input Impedance:

Thermocouple = 3 megohms minimum. RTD current = 200 μ A.
Current = 249 ohms. Voltage = 5000 ohms.

Set Point Range: Selectable.

Displays: Two 4 digit, 7 segment 0.3" high LED's. PV red, SV green.

Control Action: Reverse (usually heating), Direct (usually cooling) selectable for single or dual set point models.

Proportional Band: 6 to 5000 °F or equivalent °C for temperature inputs.
6 to 9990 counts for current or voltage inputs.

Reset Time (Integral): Off or 0.1 to 99.9 minutes.

Rate Time (Derivative): Off or 0.01 to 99.99 minutes.

Cycle Rate: 2 to 80 seconds,

Approach Rate: Off to 99.99 minutes.

On - Off Differential: Adjustable 1° F to full scale in 1° steps (equivalent °C), or 1 count to full scale in 1 count steps for current and voltage inputs.

Alarm On - Off Differential: 2° F or equivalent in °C, or 2 counts.

Accuracy: $\pm 0.25\%$ of span, ± 1 least significant digit.

Resolution: 1 degree, 0.1 degree, or 1 count.

Line Voltage Stability: $\pm 0.05\%$ over the supply voltage range.

Temperature Stability: 4 μ V/°C (2.3 μ V/°F) typical, 8 μ V/°C (4.5 μ V/°F) maximum.

Common Mode Rejection: 140 db minimum at 60 Hz.

Normal Mode Rejection: 65 db typical, 60 db at 60 Hz.

Isolation: Relay and SSR outputs are isolated. Current, voltage, and logic outputs must not share common grounds with the input.

Supply Voltage: 100 to 240 VAC, nom., +10 -15%, 50 to 400 Hz. single phase; 132 to 240 VDC, nom., +10 -20%. This applies to the instrument power only.

Power Consumption: 5VA maximum.

Operating Temperature: -10 to +55 °C (+14 to 131 °F).

Storage Temperature: -40 to +80 °C (-40 to 176 °F).

Humidity Conditions: 0 to 90% up to 40 °C non-condensing 10 to 50% at 55 °C non-condensing.

Memory Backup: Non-volatile memory. No batteries required.

Control Output Ratings:

1. SSR, 3.5 A @ 250 VAC at 25 °C. Derates to 1.25 A @ 55 °C.
2. Relay, Form A contact (SPST), 3 A @ 250 VAC resistive; 1.5 A @ 250 VAC inductive; Pilot Duty Rating: 250 VA, 2 A @ 125 VAC or 1 A @ 250 VAC.
3. Alarm Relay, Form A contact (SPST). Same rating as control relay (2) above.
4. Current (non-isolated), 0 to 20 mA across 600 ohms maximum.
5. Voltage (non-isolated), 0 to 10 VDC across 500 ohms minimum.
6. Logic (non-isolated), 5 VDC @ 25 mA.

Panel Cutout: 45 mm x 45 mm (1.775" x 1.775").

Depth Behind Mounting Surface: 115.3 mm (4.54").

Weight: 227 g (8 oz).

Agency Approvals: UL E83725, CSA LR40125.

Front Panel Rating: IP66, UL Type 4X.